

MBBN
MEU BANHEIRO NOVO

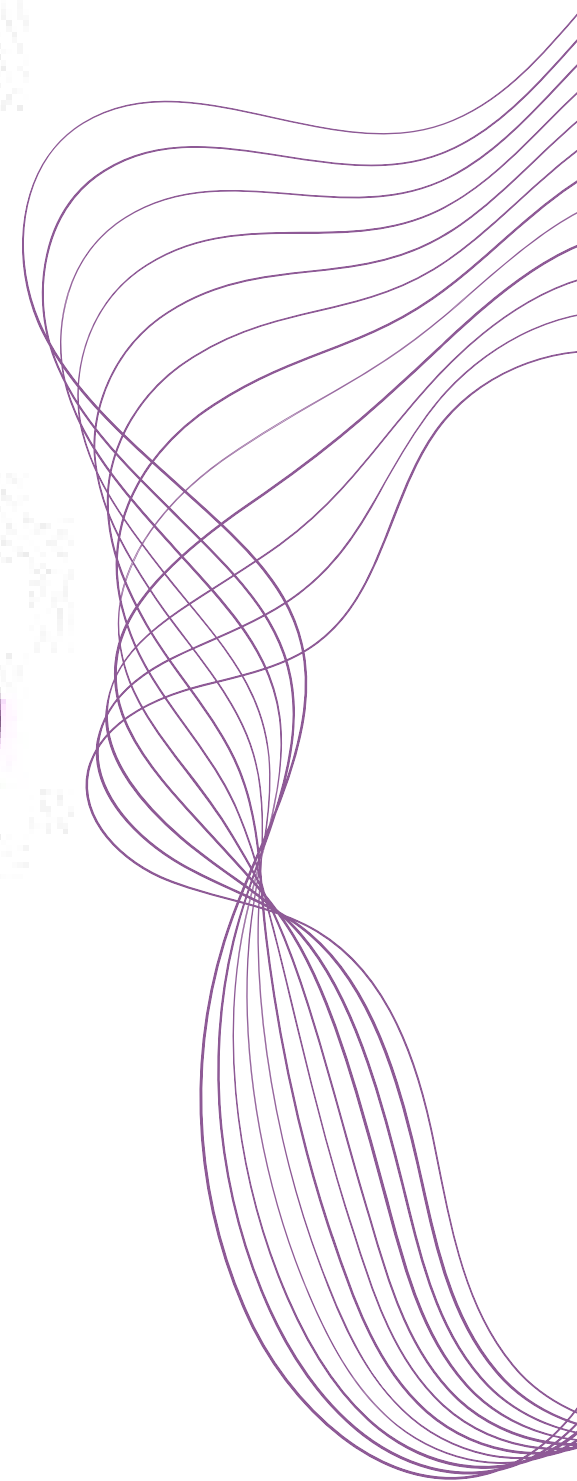

**PROJETO
REFORMA DE BANHEIRO RESIDENCIAL**

WWW.MEUBANHEIRONOVO.COM.BR



BANHEIRO SOCIAL



ANTES



DEPOIS (IMAGEM ILUSTRATIVA EM PERSPECTIVA)

BANHEIRO SOCIAL



DEPOIS (IMAGEM ILUSTRATIVA EM PERSPECTIVA)



BANHEIRO SUÍTE



ANTES



DEPOIS (IMAGEM ILUSTRATIVA EM PERSPECTIVA)



BANHEIRO SUÍTE



DEPOIS (IMAGEM ILUSTRATIVA EM PERSPECTIVA)

PROJETO EXECUTIVO

BANHEIRO SOCIAL E BANHEIRO SUÍTE

PLANTA DE LAYOUT
PLANTA DE COTAS
PAGINAÇÃO DE PISO
PONTO ELÉTRICO
FORRO E LUMINOTÉCNICO
PLANTA HIDRÁULICA
VISTAS
VISTAS HIDRÁULICA



MBN
MEU BANHEIRO NOVO

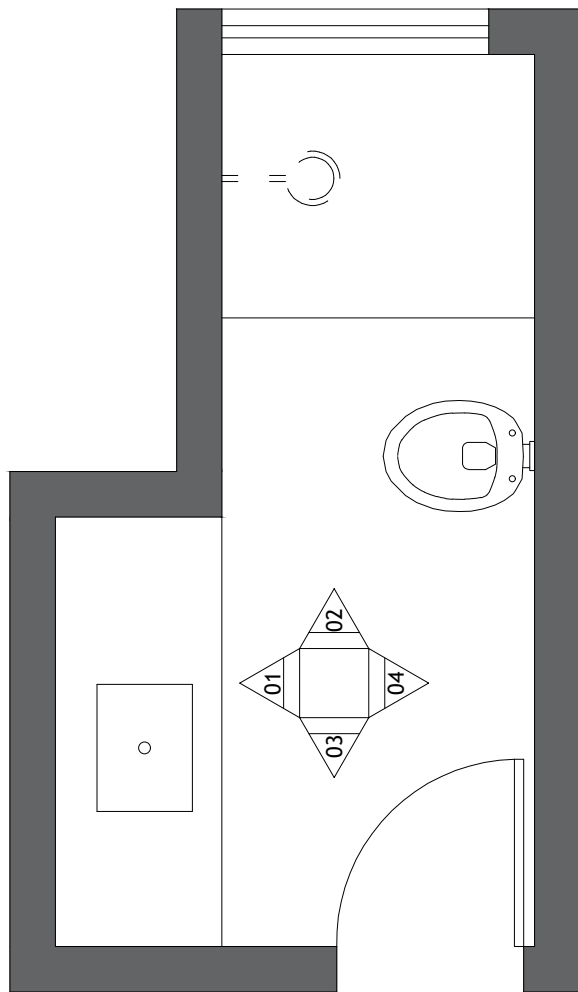

PLANTA DE LAYOUT
ESCALA 1/25

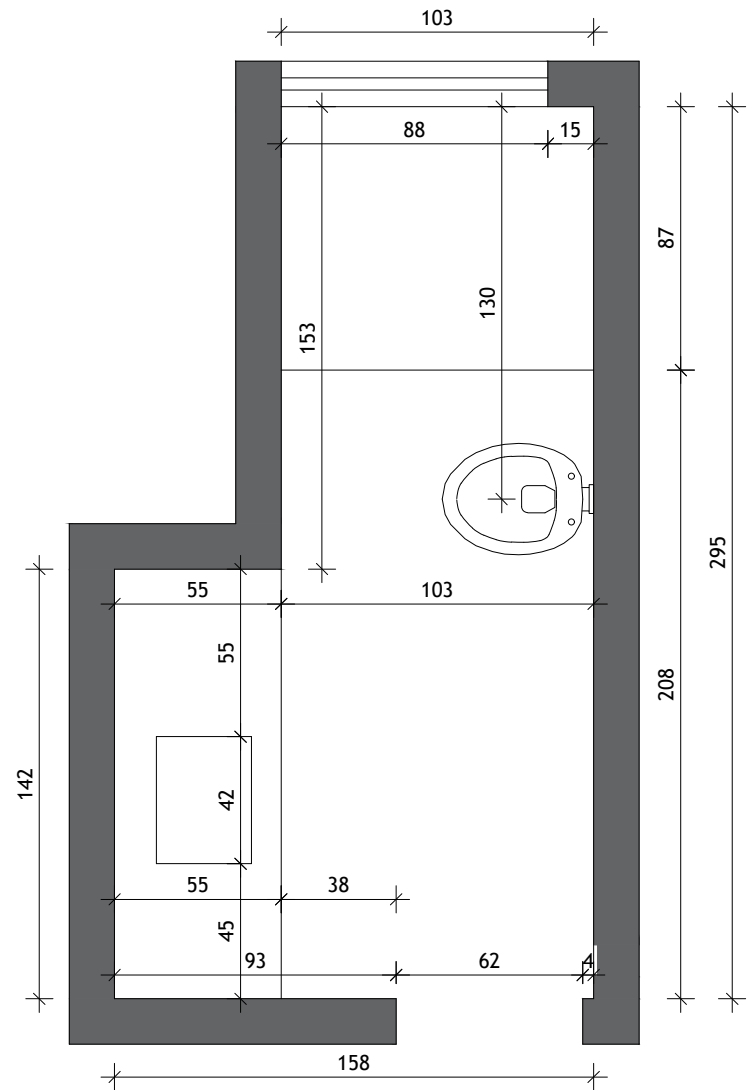

PLANTA DE COTAS
ESCALA 1/25

Cliente: ARIANI	Endereço: RUA OSCAR TROMPOWSKI 536, BAIRRO GUTIERRES	Data: 03/07/2024	Responsável SÁVIO SOARES
	Projeto: REFORMA BANHEIRO SOCIAL	Escala: 1:25	Prancha: 01/09



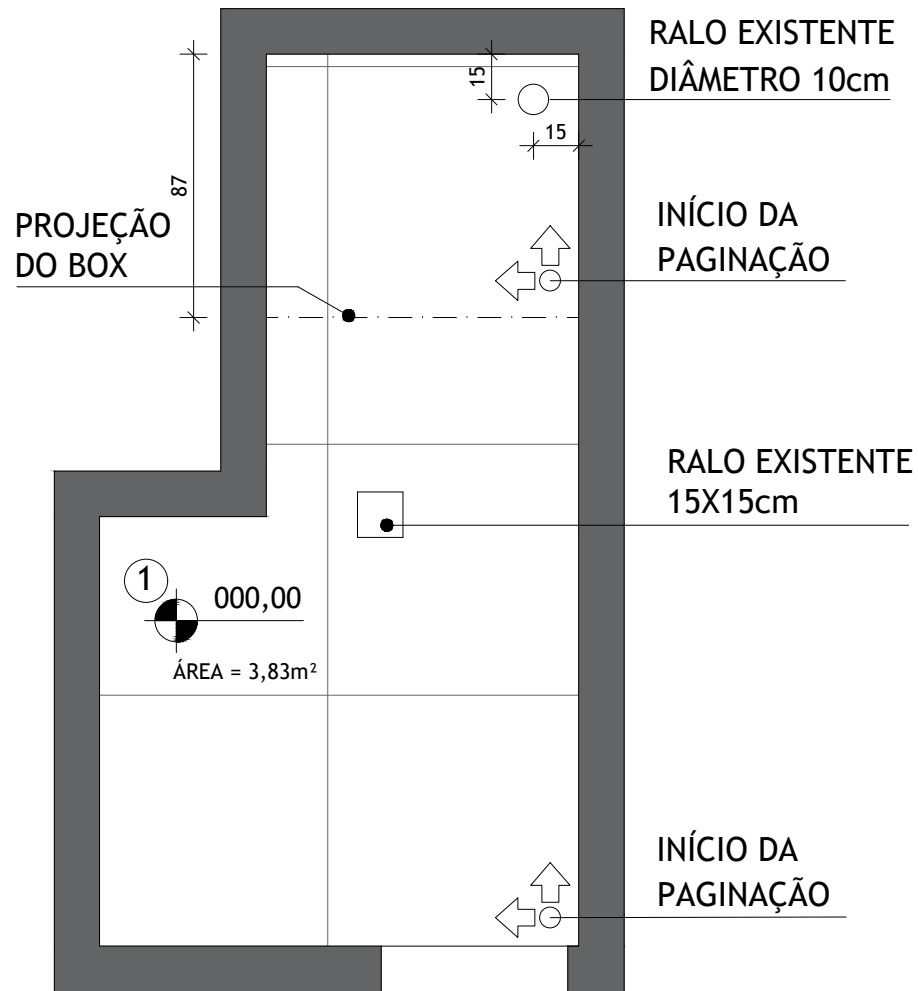

PAGINAÇÃO DE PISO

ESCALA 1/25

PORCELANATO EMBRAMACO ÔNIX
PREMIUM PLUS ACETINADO

1 83X83CM MÁRMORE RETIFICADO

ÁREA = 3,83m²

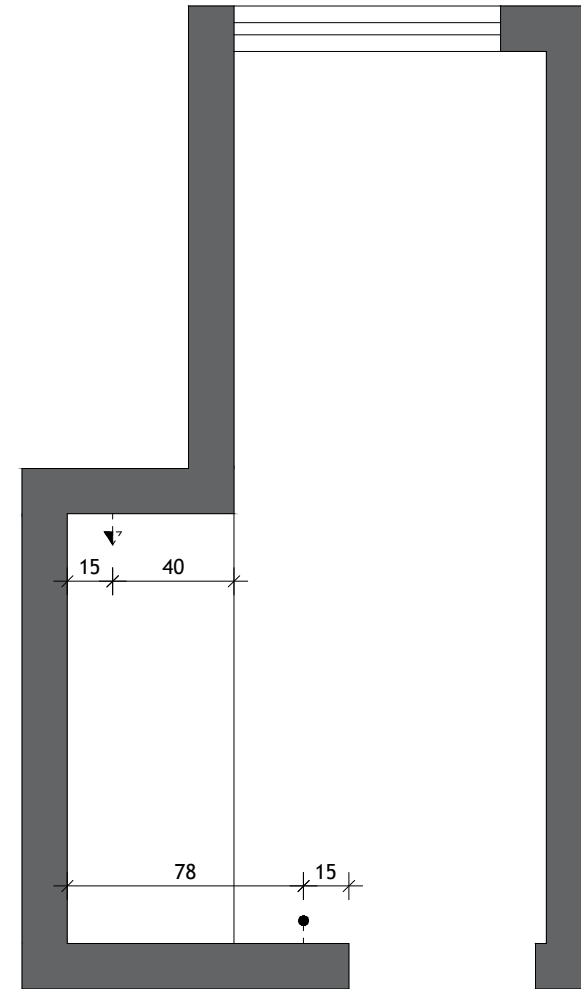

PONTO ELÉTRICO

ESCALA 1/25

▲ TOMADA MÉDIA - 110cm DO PISO ACABADO
● PONTO INTERRUPTOR

Cliente: ARIANI	Endereço: RUA OSCAR TROMPOWSKI 536, BAIRRO GUTIERRES	Data: 03/07/2024	Responsável: SÁVIO SOARES
	Projeto: REFORMA BANHEIRO SOCIAL	Escala: 1:25	Prancha: 01/09



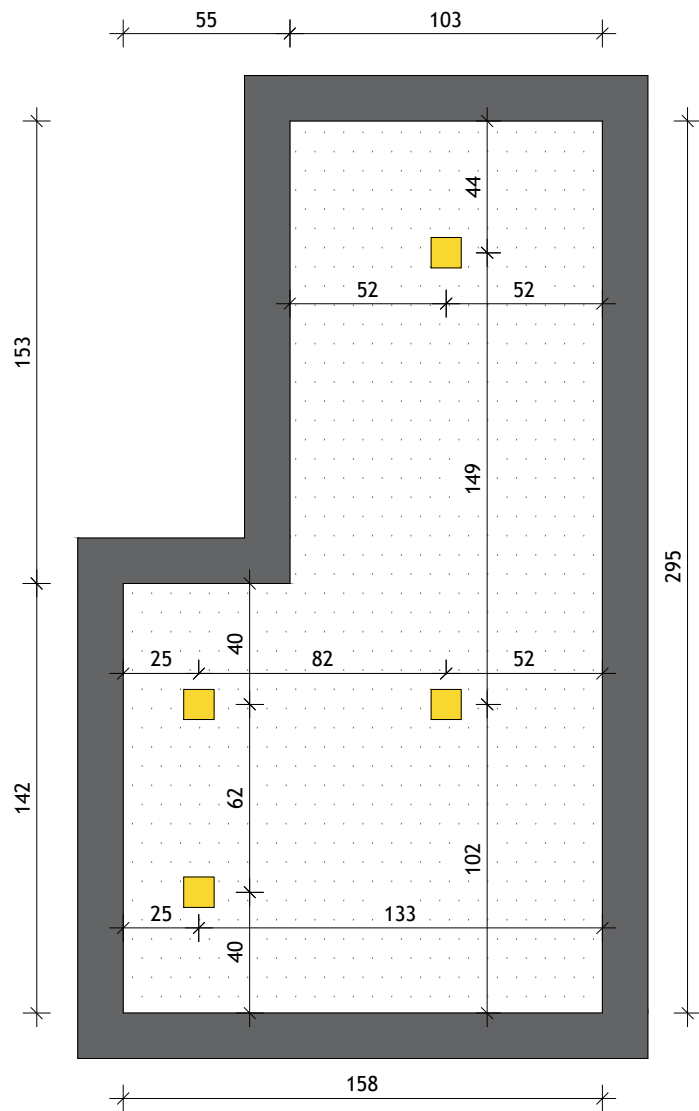

LEGENDA:

- PLANTA DE LAYOUT
- PLANTA DE COTAS
- PLANTA DE PAGINAÇÃO DE PISO
- PLANTA DE PONTO ELÉTRICO
- PLANTA DE FORRO E LUMINOTÉCNICO



- VISTA 1 VISTA 1 HIDRÁULICA
- VISTA 2 VISTA 2 HIDRÁULICA
- VISTA 3 VISTA 3 HIDRÁULICA
- VISTA 4

PORCELANATO AMADEIRADO ACETINADO BORDA RETA EXTERNO 26X106CM IPE OUTSIDE INCESA
 ÁREA TOTAL = 3,71m²

PORCELANATO EMBRAMACO ÔNIX PREMIUM PLUS ACETINADO 83X83CM MÁRMORE RETIFICADO
 ÁREA TOTAL = 14,80m²

FORRO E LUMINOTÉCNICO

ESCALA 1/25

-  REBAIXO DE GESSO H= 241cm
ÁREA 3,83m²
-  PAINEL LED DE EMBUTIR
360 LUMENS 3000K

Cliente: ARIANI	Endereço: RUA OSCAR TROMPOWSKI 536, BAIRRO GUTIERRES	Data: 03/07/2024	Responsável SÁVIO SOARES
	Projeto: REFORMA BANHEIRO SOCIAL	Escala: 1:25	Prancha: 01/09



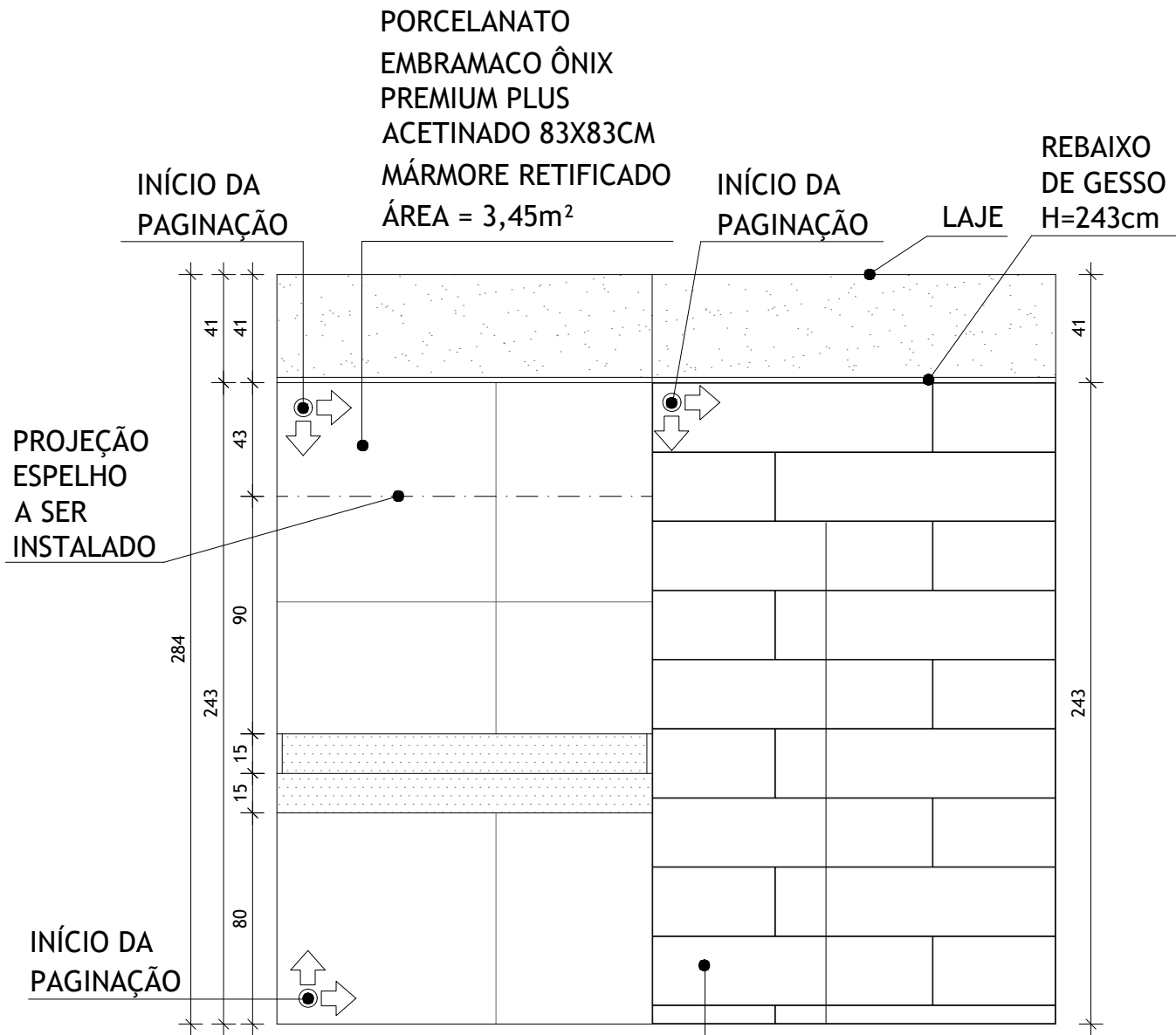

VISTA 1
ESCALA 1/25

PORCELANATO AMADEIRADO
ACETINADO BORDA RETA EXTERNO
26X106CM IPE OUTSIDE INCESA
ÁREA = 3,71m²

Cliente: ARIANI	Endereço: RUA OSCAR TROMPOWSKI 536, BAIRRO GUTIERRES	Data: 03/07/2024	Responsável SÁVIO SOARES	
	Projeto: REFORMA BANHEIRO SOCIAL	Escala: 1:25	Prancha: 04/09	

INÍCIO DA
PAGINAÇÃO

LAJE

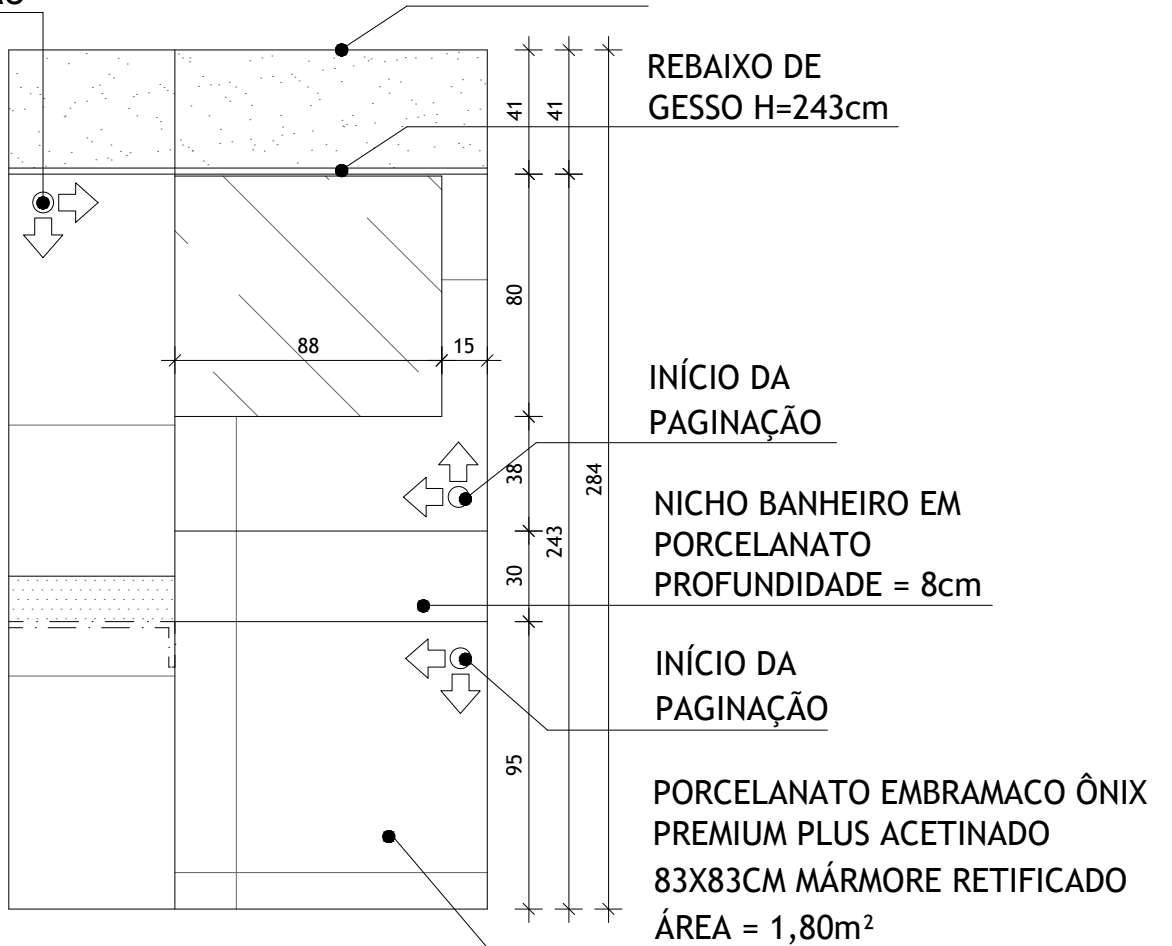

VISTA 2

ESCALA 1/25

Cliente: ARIANI	Endereço: RUA OSCAR TROMPOWSKI 536, BAIRRO GUTIERRES	Data: 03/07/2024	Responsável: SÁVIO SOARES	
	Projeto: REFORMA BANHEIRO SOCIAL	Escala: 1:25	Prancha: 05/09	

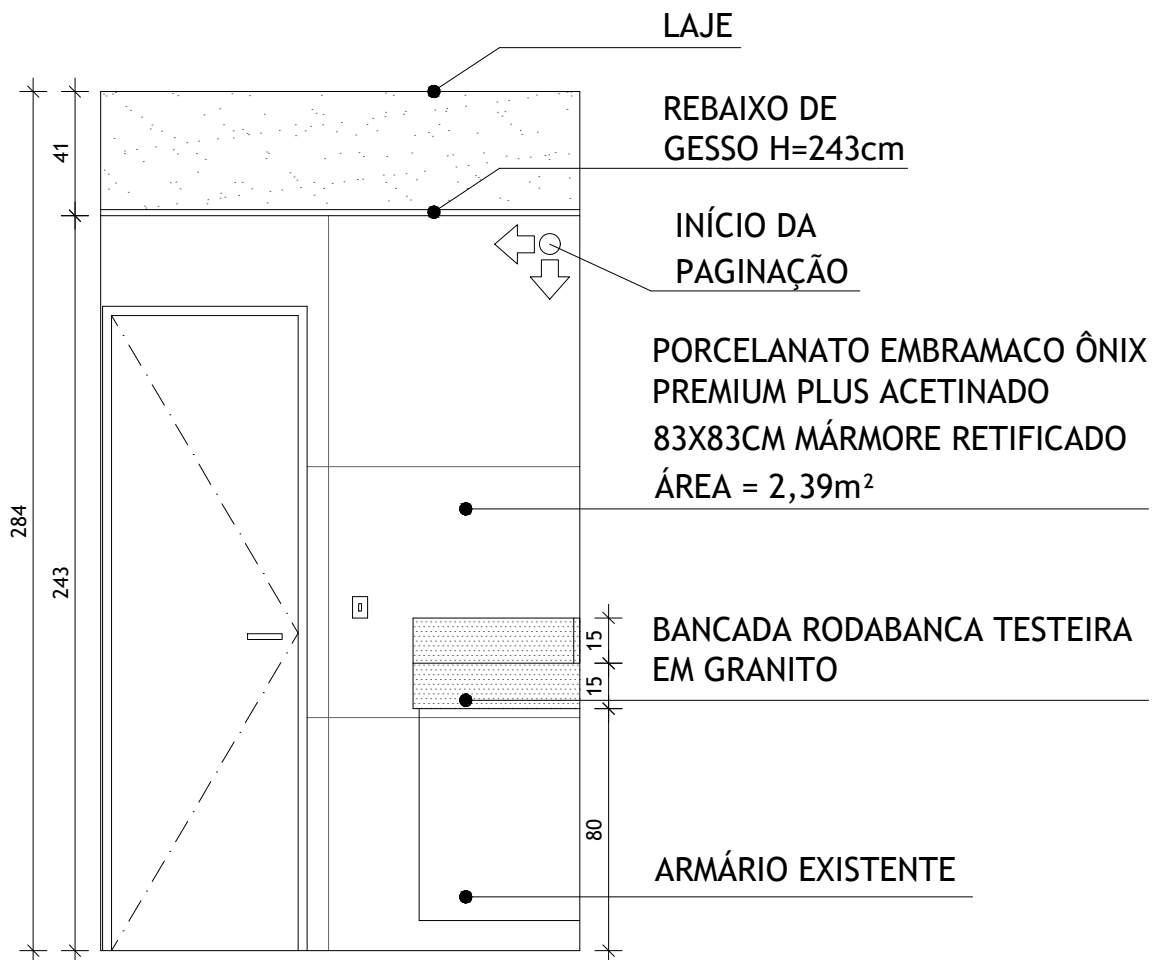

VISTA 3
ESCALA 1/25

Cliente: ARIANI	Endereço: RUA OSCAR TROMPOWSKI 536, BAIRRO GUTIERRES	Data: 03/07/2024	Responsável SÁVIO SOARES	
	Projeto: REFORMA BANHEIRO SOCIAL	Escala: 1:25	Prancha: 06/09	

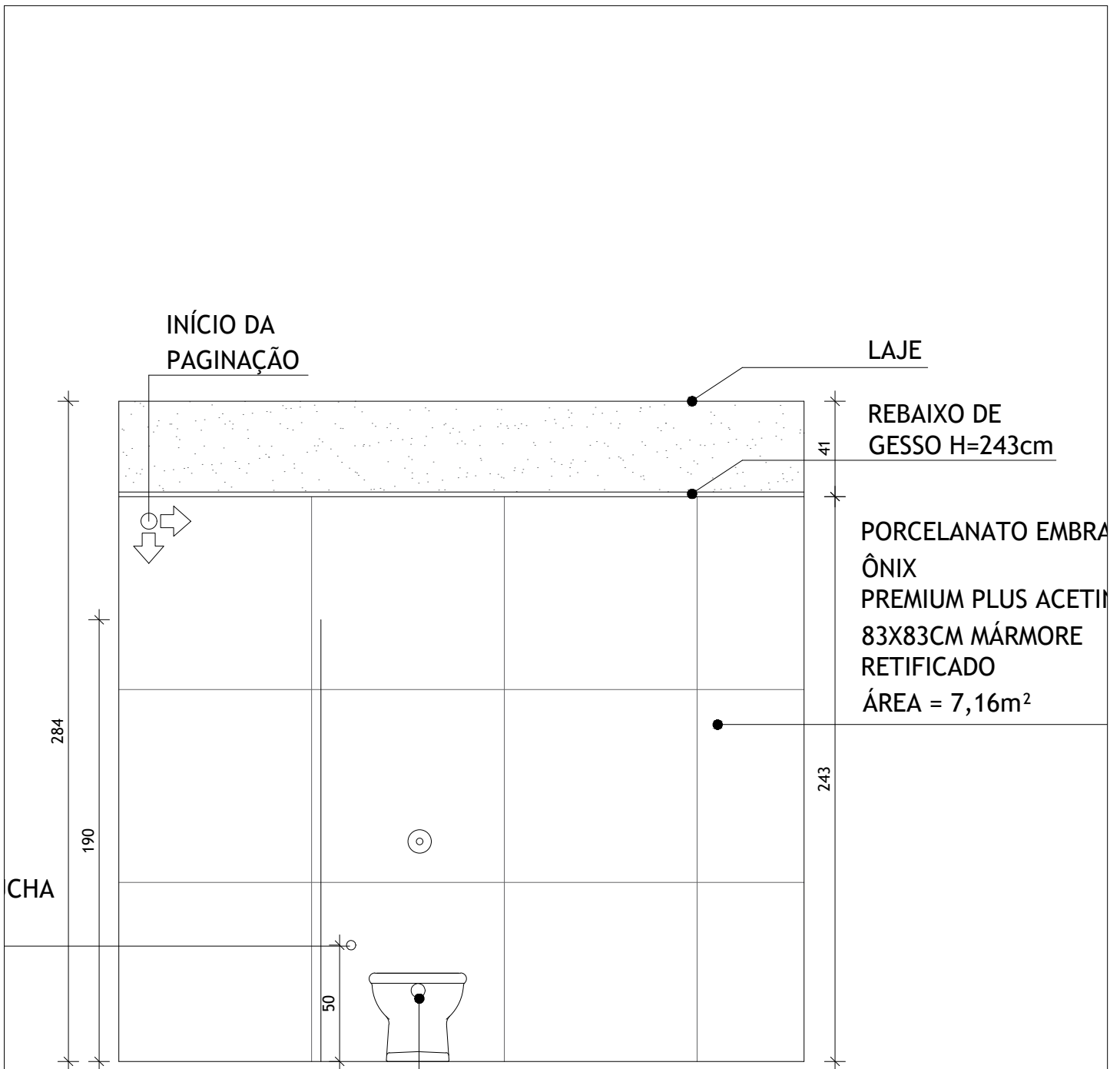

VISTA 4
ESCALA 1/25

ENCANAMENTO EXISTENTE
PARA ACOPLAMENTO DO
VASO SANITÁRIO

Cliente: ARIANI	Endereço: RUA OSCAR TROMPOWSKI 536, BAIRRO GUTIERRES	Data: 03/07/2024	Responsável: SÁVIO SOARES	
	Projeto: REFORMA BANHEIRO SOCIAL	Escala: 1:25	Prancha: 07/09	

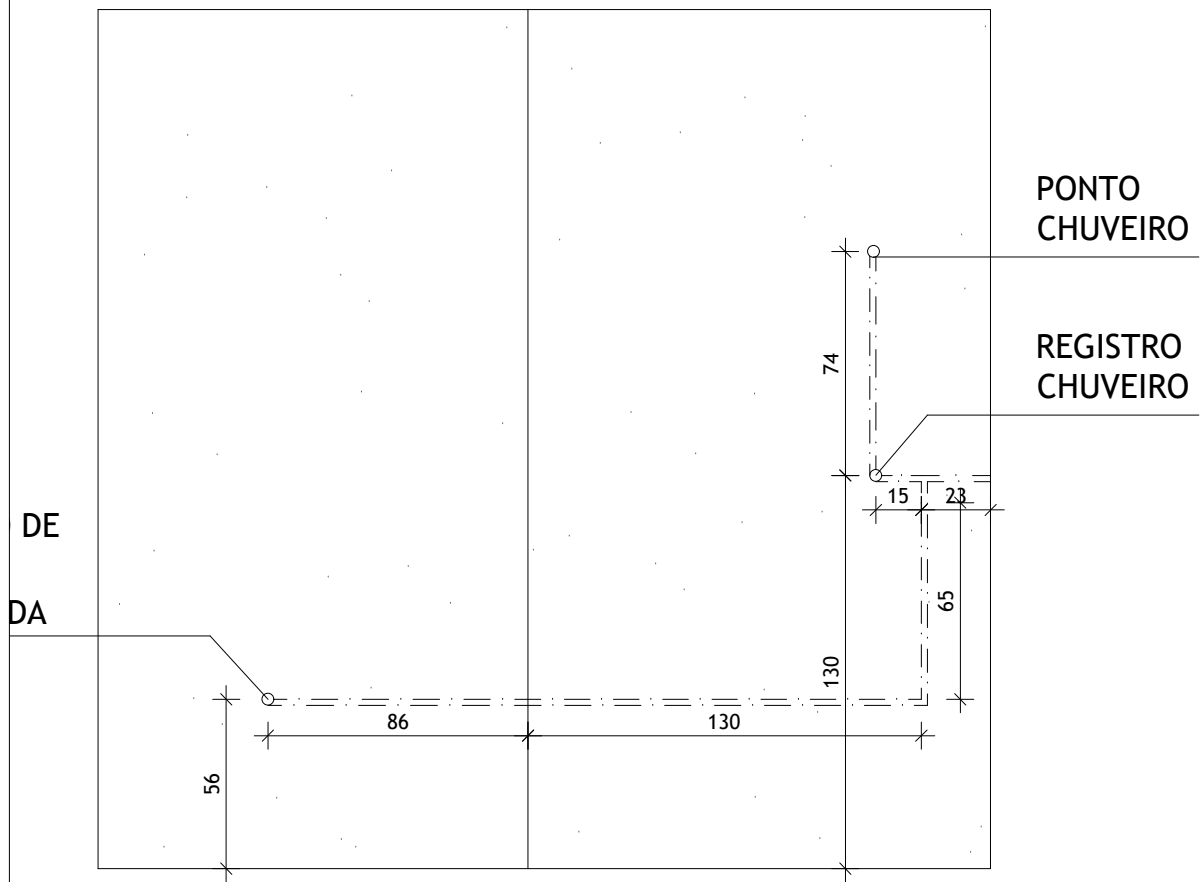

VISTA 1 HIDRÁULICA
ESCALA 1/25

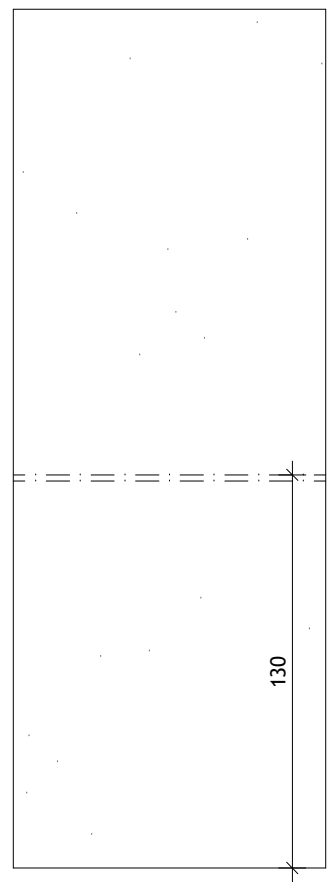

VISTA 2 HIDRÁULICA
ESCALA 1/25

Cliente: ARIANI	Endereço: RUA OSCAR TROMPOWSKI 536, BAIRRO GUTIERRES	Data: 03/07/2024	Responsável SÁVIO SOARES	
	Projeto: REFORMA BANHEIRO SOCIAL	Escala: 1:25	Prancha: 08/09	

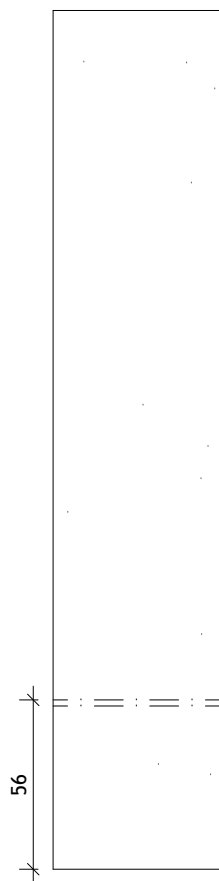

VISTA 2 HIDRÁULICA
ESCALA 1/25

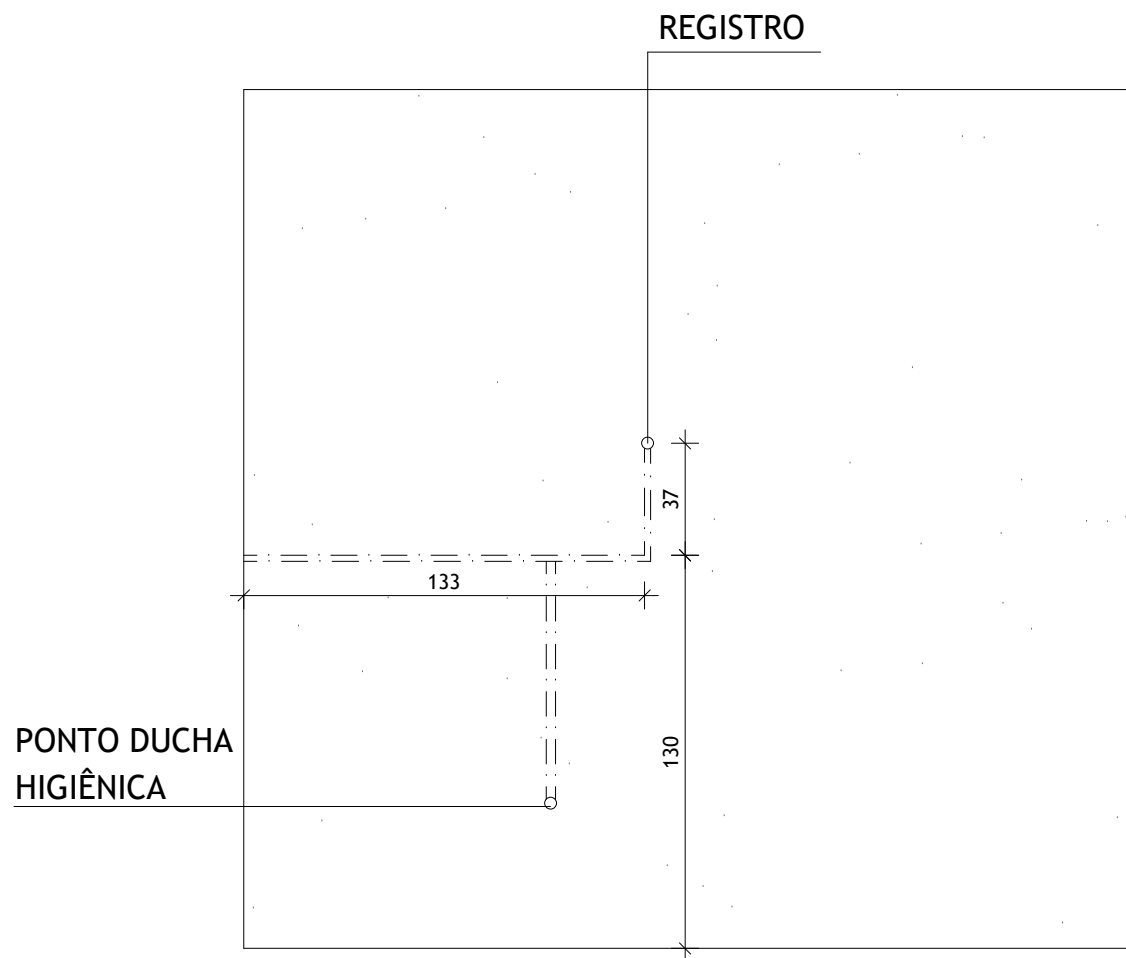

VISTA 4 HIDRÁULICA
ESCALA 1/25

Cliente: ARIANI	Endereço: RUA OSCAR TROMPOWSKI 536, BAIRRO GUTIERRES	Data: 03/07/2024	Responsável SÁVIO SOARES	
	Projeto: REFORMA BANHEIRO SOCIAL	Escala: 1:25	Prancha: 09/09	

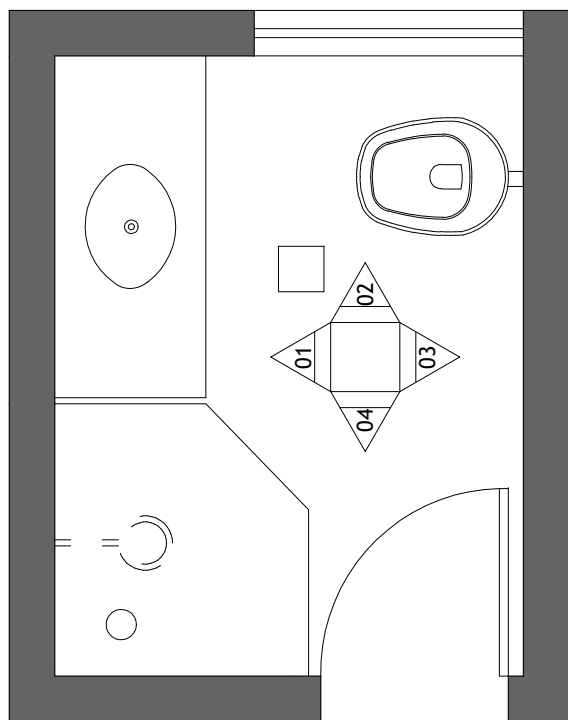

PLANTA DE LAYOUT
ESCALA 1/25

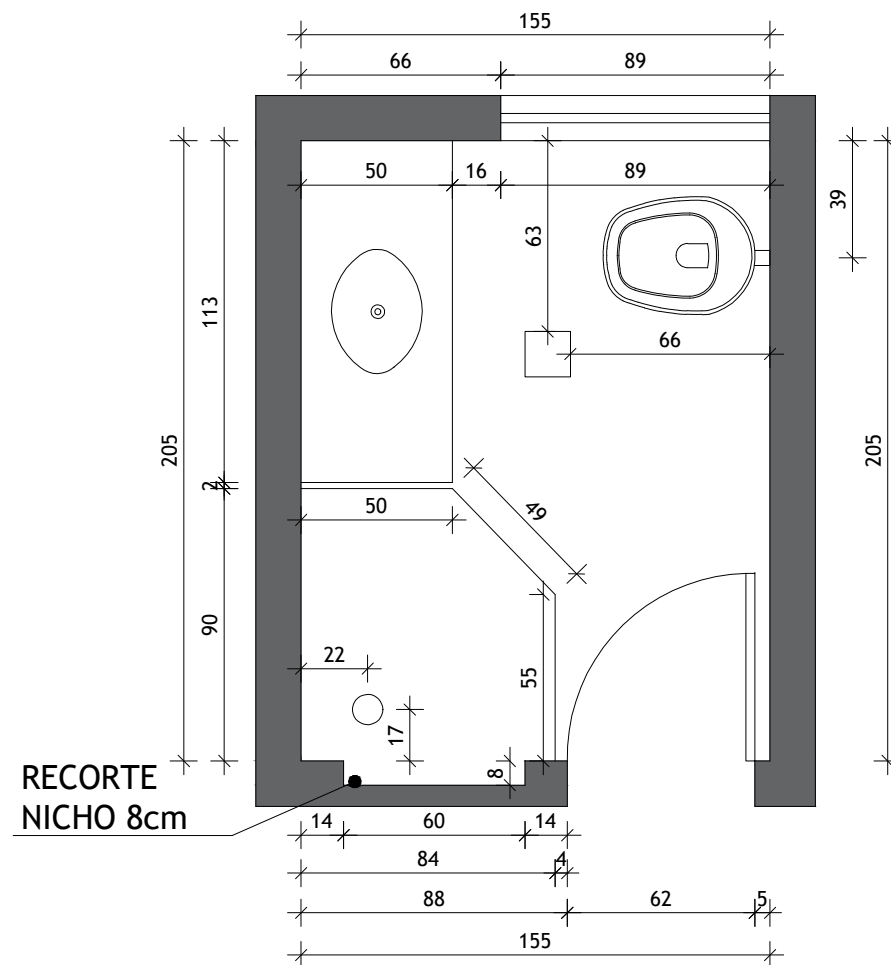

RECORTE
NICHOS 8cm

PLANTA DE COTAS
ESCALA 1/25

Cliente: ARIANI	Endereço: RUA OSCAR TROMPOWSKI 536, BAIRRO GUTIERRES	Data: 03/07/2024	Responsável SÁVIO SOARES
	Projeto: REFORMA BANHEIRO	Escala: 1:25	Prancha: 01/10



PROJEÇÃO
DO BOX

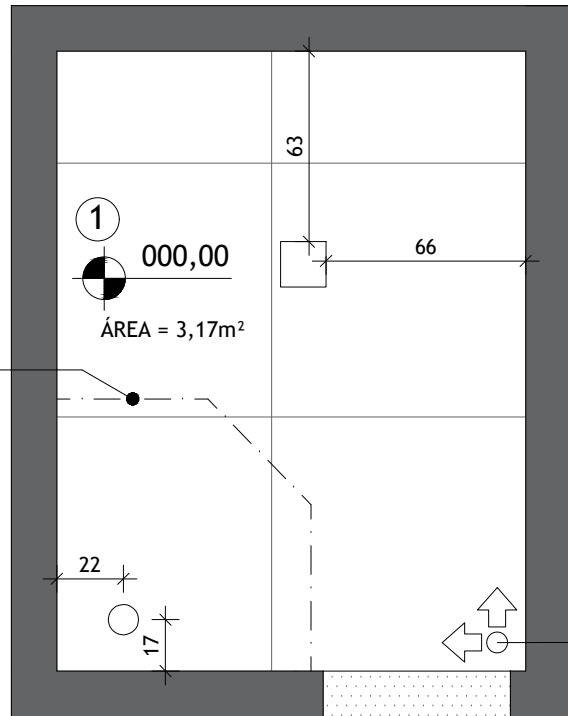

INÍCIO DA
PAGINAÇÃO

PAGINAÇÃO DE PISO

ESCALA 1/25

- 1 PORCELANATO EMBRAMACO ÔNIX
PREMIUM PLUS ACETINADO
83X83CM MÁRMORE RETIFICADO
ÁREA = 3,17m²

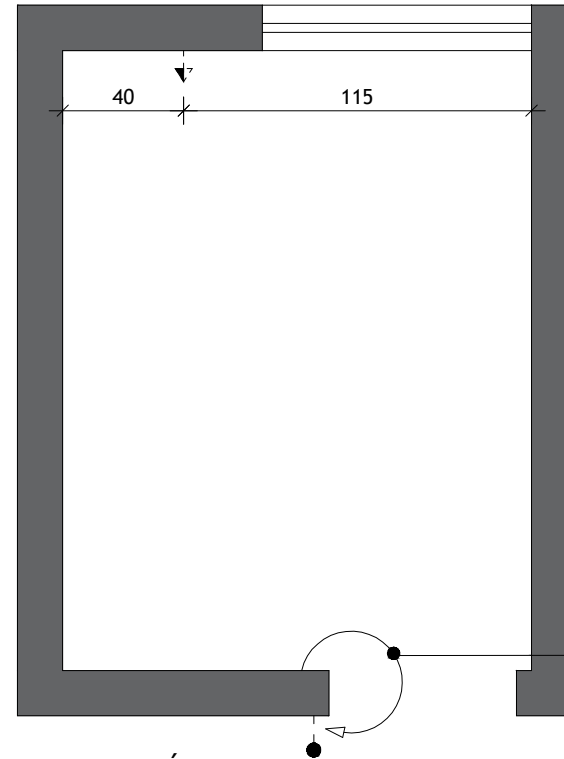

MUDAR O
INTERRUPTOR PARA
FORA DO BANHEIRO

PONTO ELÉTRICO

ESCALA 1/25

- ↑ TOMADA MÉDIA - 130cm DO PISO ACABADO
⬇ PUNTO INTERRUPTOR

Cliente:
ARIANI

Endereço: RUA OSCAR TROMPOWSKI
536, BAIRRO GUTIERRES

Data:
03/07/2024

Responsável
SÁVIO SOARES

Projeto: REFORMA BANHEIRO

Escala:
1:25

Prancha:
02/10



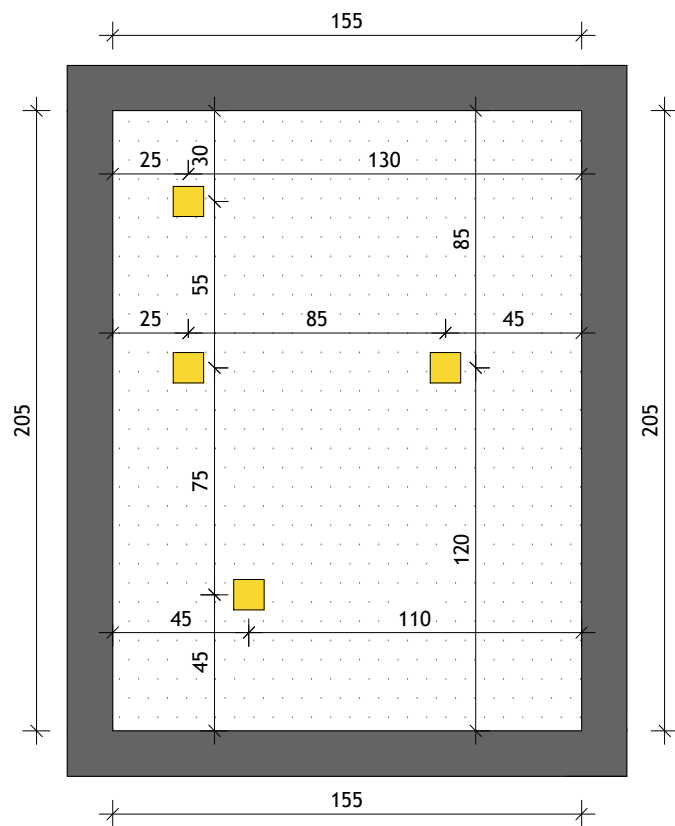

FORRO E LUMINOTECNICO

ESCALA 1/25



REBAIXO DE GESSO H= 241cm

ÁREA 3,17m²



PAINEL LED DE EMBUTIR
360 LUMENS 3000K

LEGENDA:

PLANTA DE LAYOUT
 PLANTA DE COTAS
 PLANTA DE PAGINAÇÃO DE PISO
 PLANTA DE PONTO ELÉTRICO
 PLANTA DE FORRO E LUMINOTÉCNICO

VISTA 1 VISTA 1 HIDRÁULICA
 VISTA 2 VISTA 2 HIDRÁULICA
 VISTA 3 VISTA 3 HIDRÁULICA
 VISTA 4

PORCELANATO AMADEIRADO ACETINADO BORDA RETA
 EXTERNO 26X106CM IPE OUTSIDE INCESA
 ÁREA TOTAL = 2,16m²

PORCELANATO EMBRAMACO ÔNIX PREMIUM PLUS
 ACETINADO 83X83CM MÁRMORE RETIFICADO
 ÁREA TOTAL = 16,24m²

Cliente: ARIANI	Endereço: RUA OSCAR TROMPOWSKI 536, BAIRRO GUTIERRES	Data: 03/07/2024	Responsável SÁVIO SOARES
	Projeto: REFORMA BANHEIRO	Escala: 1:25	Prancha: 03/10



PORCELANATO EMBRAMACO ÔNIX
 PREMIUM PLUS ACETINADO
 83X83CM MÁRMORE RETIFICADO
 ÁREA = 2,77m²

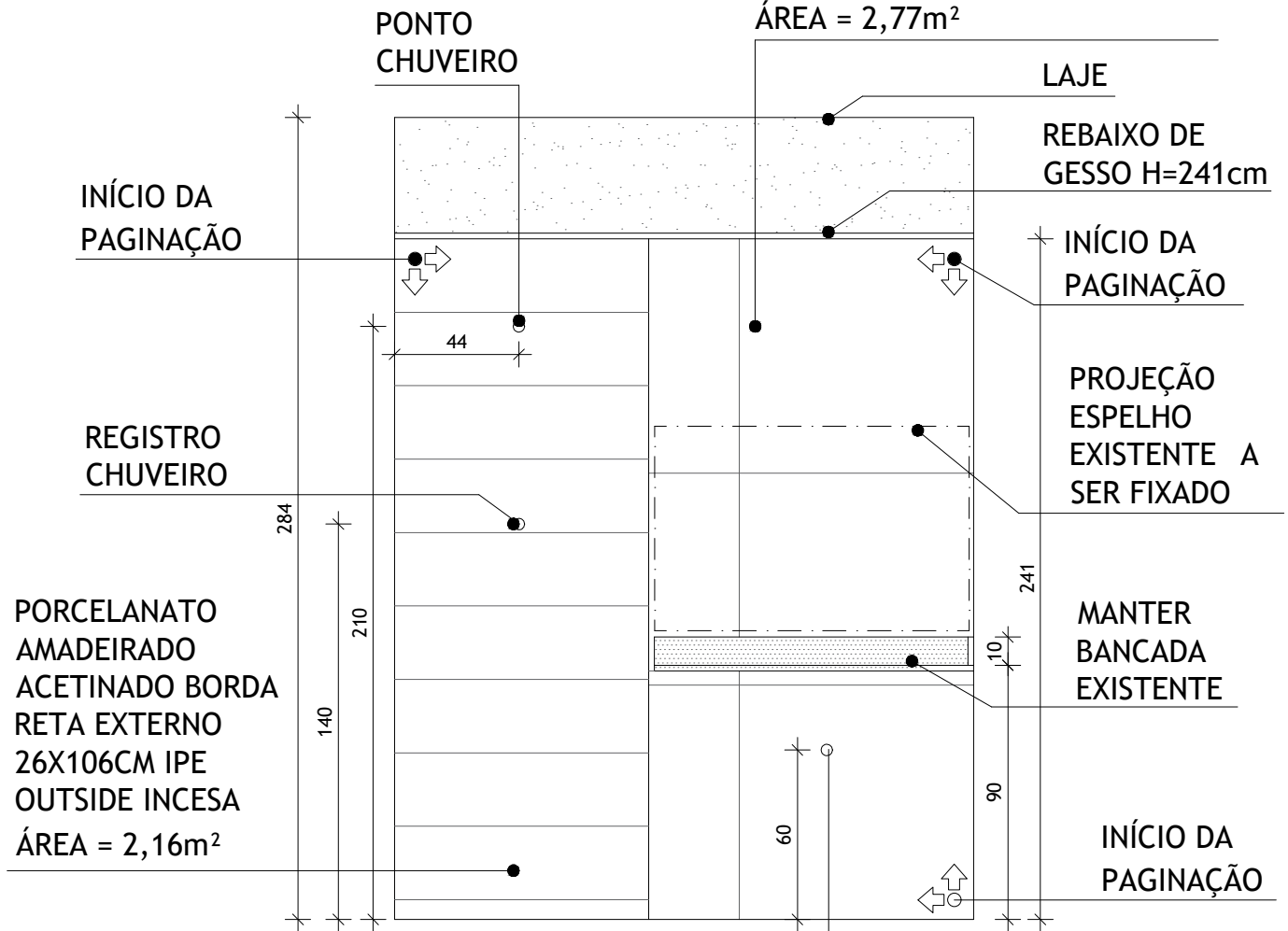

VISTA 1
ESCALA 1/25

Cliente: ARIANI	Endereço: RUA OSCAR TROMPOWSKI 536, BAIRRO GUTIERRES	Data: 03/07/2024	Responsável: SÁVIO SOARES	
	Projeto: REFORMA BANHEIRO	Escala: 1:25	Prancha: 04/10	

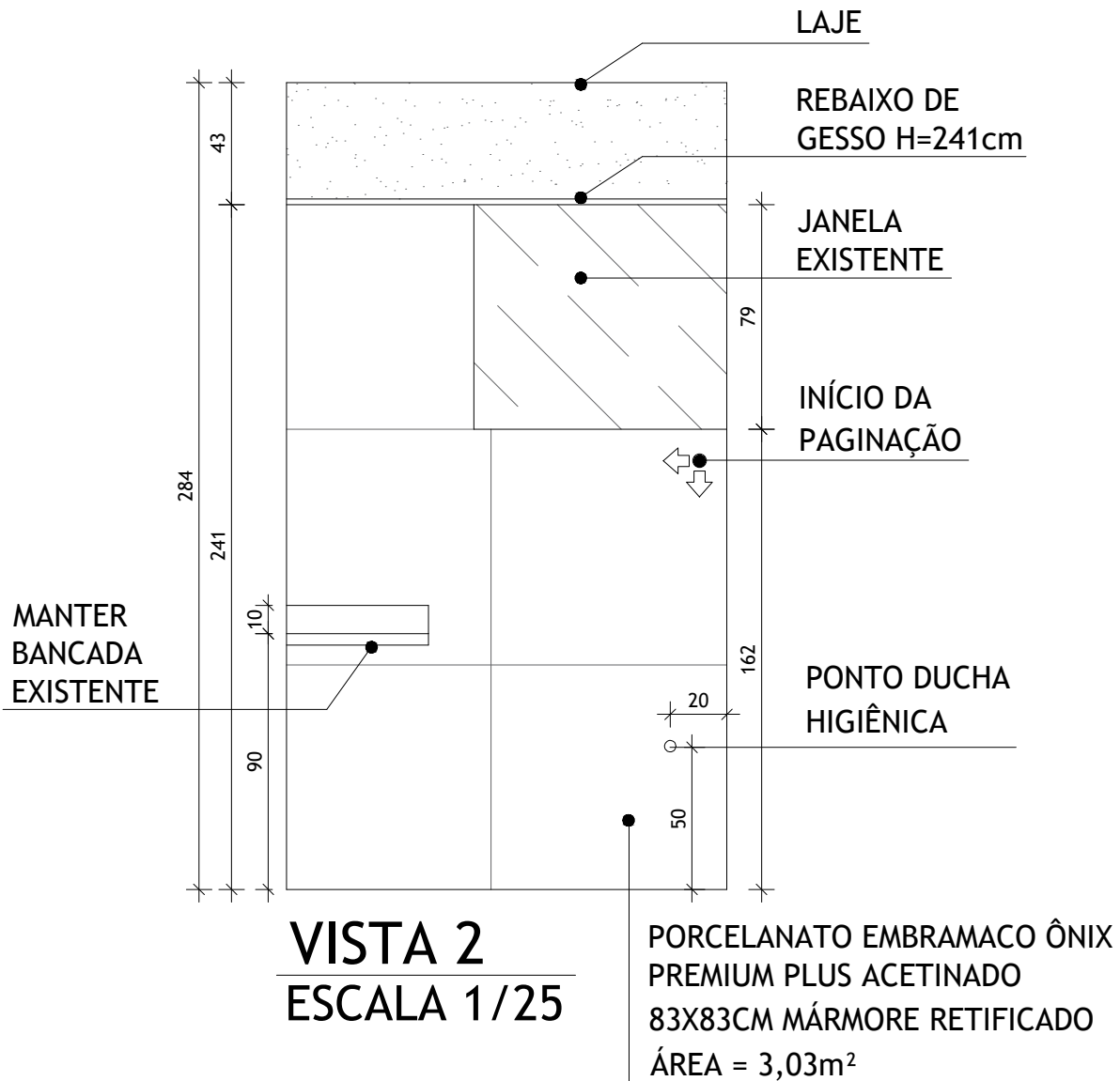

Cliente: ARIANI	Endereço: RUA OSCAR TROMPOWSKI 536, BAIRRO GUTIERRES	Data: 03/07/2024	Responsável: SÁVIO SOARES	
	Projeto: REFORMA BANHEIRO	Escala: 1:25	Prancha: 05/10	

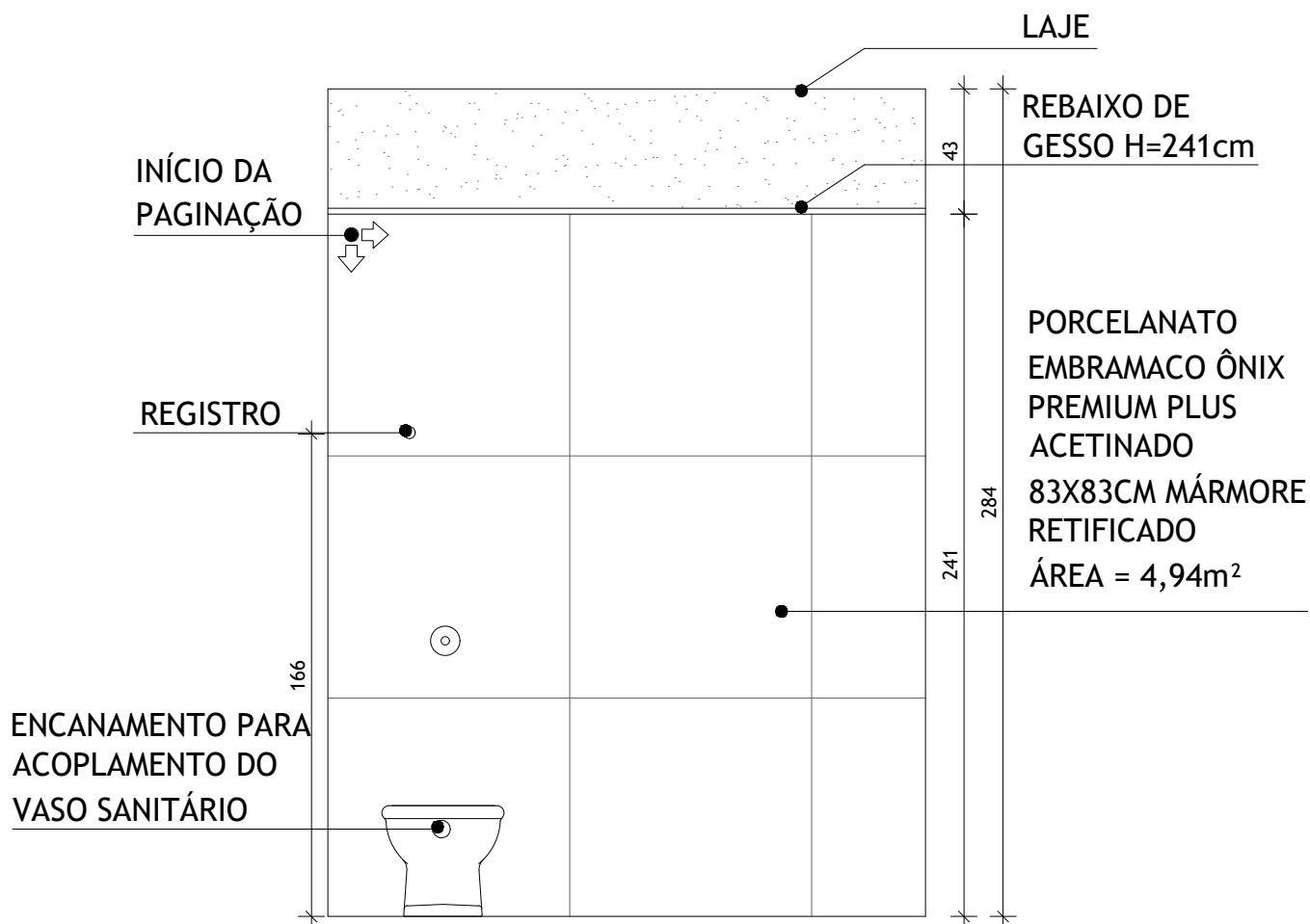

VISTA 3
ESCALA 1/25

Cliente: ARIANI	Endereço: RUA OSCAR TROMPOWSKI 536, BAIRRO GUTIERRES	Data: 03/07/2024	Responsável SÁVIO SOARES	
	Projeto: REFORMA BANHEIRO	Escala: 1:25	Prancha: 06/10	

PORCELANATO EMBRAMACO ÔNIX
 PREMIUM PLUS ACETINADO
 83X83CM MÁRMORE RETIFICADO
 ÁREA = 2,33m²

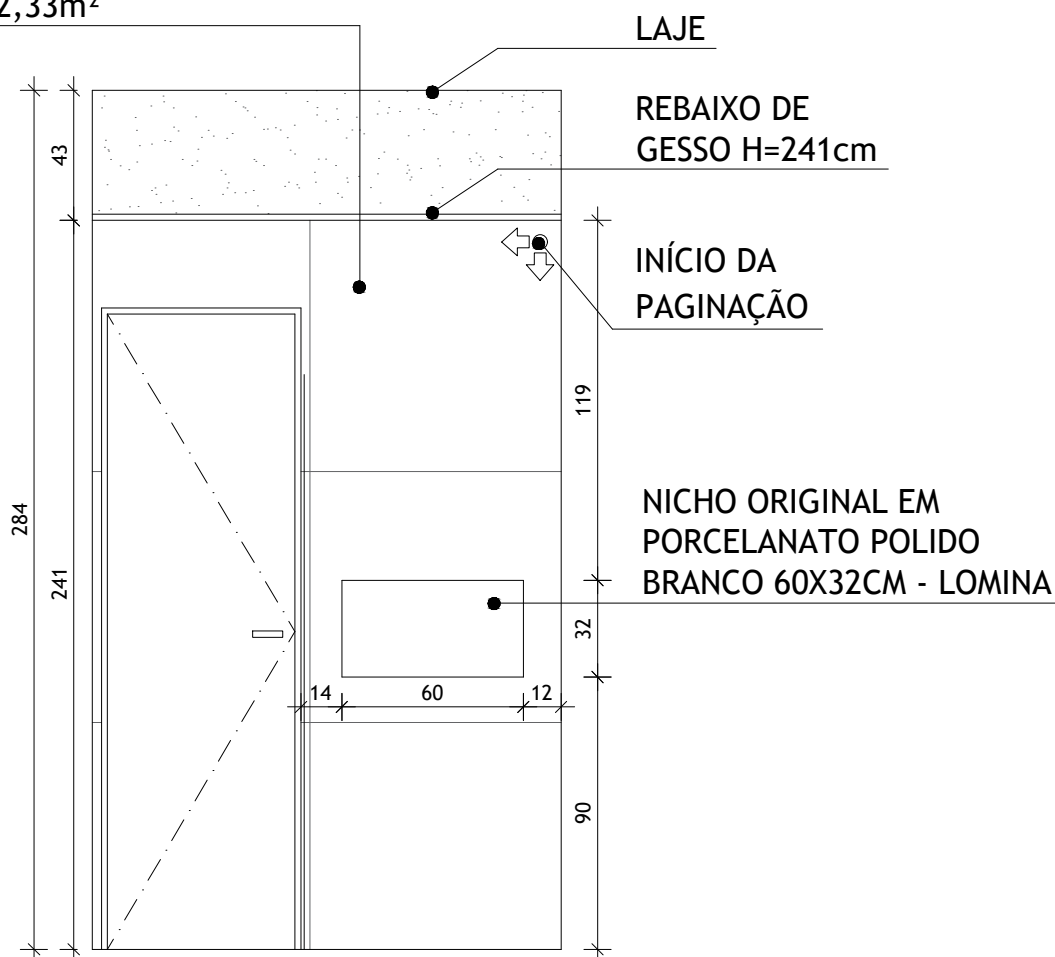

VISTA 4
ESCALA 1/25

Cliente: ARIANI	Endereço: RUA OSCAR TROMPOWSKI 536, BAIRRO GUTIERRES	Data: 03/07/2024	Responsável SÁVIO SOARES	
	Projeto: REFORMA BANHEIRO	Escala: 1:25	Prancha: 07/10	

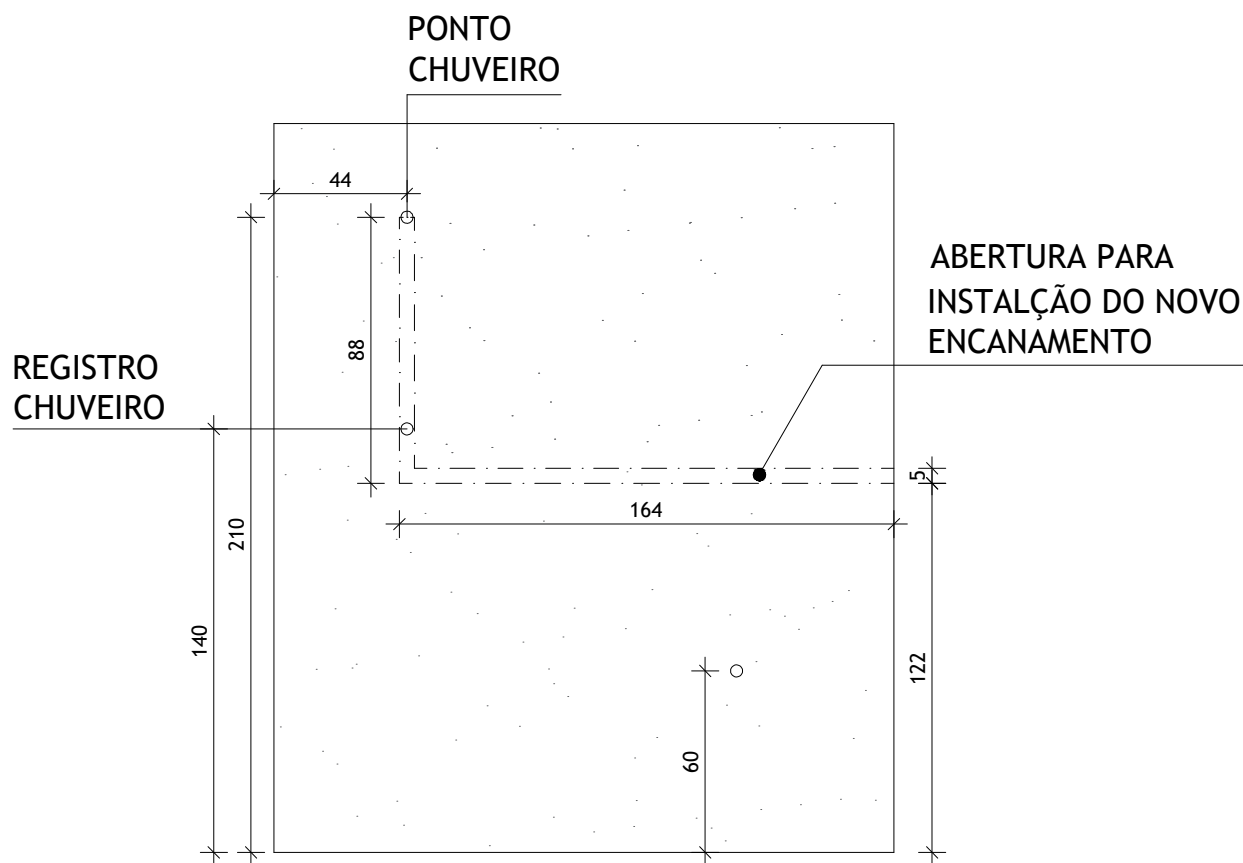

VISTA 1 HIDRÁULICA

ESCALA 1/25

Cliente: ARIANI	Endereço: RUA OSCAR TROMPOWSKI 536, BAIRRO GUTIERRES	Data: 03/07/2024	Responsável SÁVIO SOARES	
	Projeto: REFORMA BANHEIRO	Escala: 1:25	Prancha: 08/10	

ABERTURA
PARA
INSTALAÇÃO DO
NOVO
ENCANAMENTO

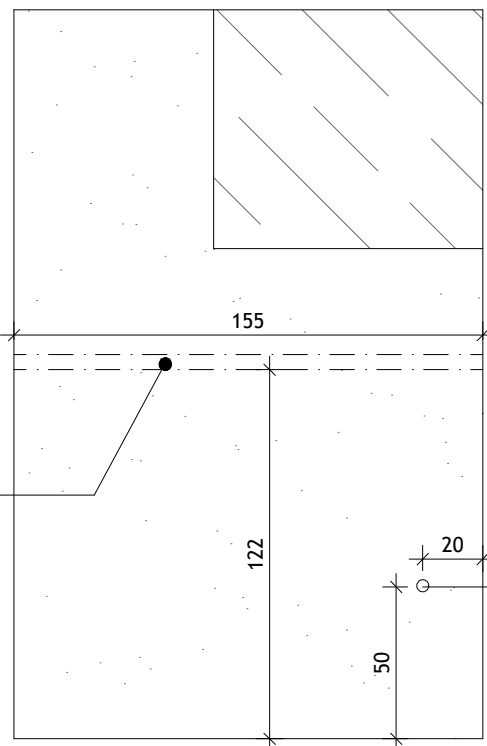

PONTO DUCHA
HIGIÊNICA

VISTA 2 HIDRÁULICA

ESCALA 1/25

Cliente: ARIANI	Endereço: RUA OSCAR TROMPOWSKI 536, BAIRRO GUTIERRES	Data: 03/07/2024	Responsável: SÁVIO SOARES	
	Projeto: REFORMA BANHEIRO	Escala: 1:25	Prancha: 09/10	

REGISTRO
PRINCIPAL

ABERTURA
PARA
INSTALAÇÃO DO
NOVO
ENCANAMENTO

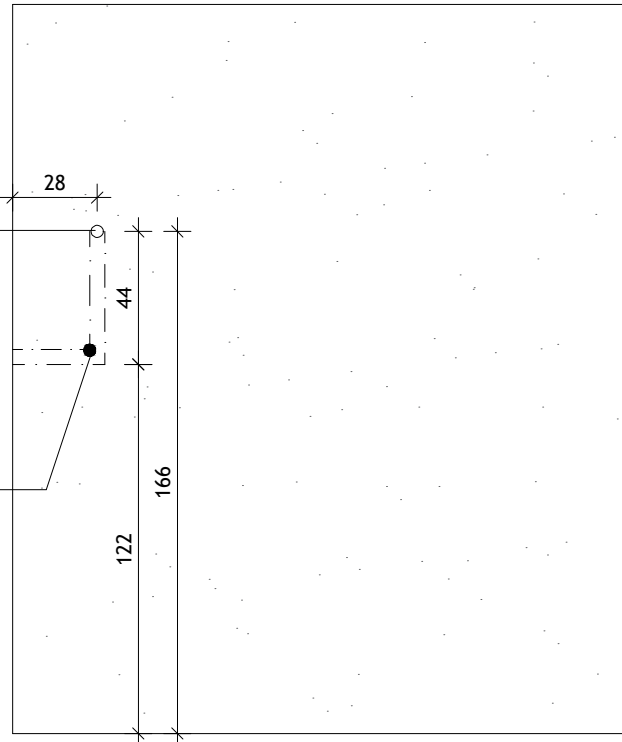

VISTA 3 HIDRÁULICA

ESCALA 1/25

Cliente: ARIANI	Endereço: RUA OSCAR TROMPOWSKI 536, BAIRRO GUTIERRES	Data: 03/07/2024	Responsável: SÁVIO SOARES	
	Projeto: REFORMA BANHERIO	Escala: 1:25	Prancha: 10/10	